

D-SERIES CRAWLER EXCAVATORS
CX350D / CX370D / CX370D 2 PIECE BOOM
STAGE V

CASE
CONSTRUCTION



IT'S TIME
FOR MORE

www.casece.com
EXPERTS FOR THE REAL WORLD
SINCE 1842

HERITAGE

A TRADITION OF INDUSTRY FIRSTS



EXPERTS FOR THE REAL WORLD SINCE 1842

1842 CASE is founded.

1869 The first CASE portable steam engine - road construction is born.

1957 The first factory - integrated loader/backhoe in the world: a CASE industry first.

1969 CASE begins skid steer loader production.

1992 Sumitomo becomes supplier to CASE Corporation distributing excavators ranging from 7 to 80 tons.

1998 Global Alliance signed

between CASE Corporation and Sumitomo.

2001 CASE introduces the first of its CX excavators, powerful new "thinking machines" designed to enhance productivity through onboard intelligence features.

2007 CX210B is awarded the «Good Design Award» by the design Academy of Japan.

2008 CX210B wins the 18th «Energy Conservation Award» from the Agency for Natural Resources and Energy of the Japanese

Ministry of Economy.

2011 CASE becomes the first construction equipment manufacturer to offer both selective catalytic reduction and cooled exhaust gas recirculation as solutions to meet stringent emissions standards.

2015 CASE launches the new "D series" Tier 4 final/ EU Stage IV Crawler Excavators.

2018 Stage V production for models CX350D and above.

CRAWLER EXCAVATORS D-SERIES

BUILT TO LAST AND CONTROL



HIGH RELIABILITY

Improved D-esign for D-urable performances

- The boom and arm have been re-designed according to the latest stress analysis criteria, to reduce stress points while maintaining weight optimization to ensure the best lifting performance.
- New high strength casting parts with joined hinge flanges reduce stress and increase durability.
- The undercarriage has been re-designed and re-shaped to facilitate the welding process, enhancing the reliability of the fabricated structures.
- The One-Side-Slope lower frame design reduces the time needed to clean the undercarriage.
- The thickness of the structural plates has been increased, especially in those parts where a high level of protection is required for components.

HIGH QUALITY

Accurate, simple and robust design for high durability

- True to CASE's enviable reputation for reliability and durability, the D-series delivers leading design solutions and manufacturing quality.
- Wide choice of arm solutions.
- Standard Heavy-Duty boom and arm on the CX370D.



HIGH PRECISION AND CONTROLLABILITY

Smooth control with the CASE Intelligent Hydraulic System

The proven CASE Intelligent Hydraulic System (CIHS) delivers energy savings in all cycle time phases (digging, boom up and swing, dumping).

D-SERIES CRAWLER EXCAVATORS



HIGH VERSATILITY

Mono or 2 Piece Boom: choice is yours!

- CX350D Mono with 4 arms options.
- CX370D Mono with 3 Heavy Duty arms options.
- A brand new specific CX370D 2-Piece Boom version is now available to provide greater performance when working closer to the machine is needed.

Working modes easily adapt to every work load

The familiar **working mode systems** offers 3 power modes to match different customer needs.

- A** MODE: for grading, lifting and precision work.
- H** MODE: the best balance between productivity and fuel economy.
- SP** MODE: extra speed and power for the most demanding jobs that require maximum productivity.

Auto Power boost automatically increases hydraulic pressure according to the operation's demands.



FAST CYCLES

High Performance Hydraulics control

- The new electrically controlled pumps and a bigger main control valve deliver faster cycle times.
- Oil flow can be adjusted according to working needs, or increased smoothly while starting travel and boom down.
- As a result, the machine responsiveness to operation load is multiplied, resulting in cycle times up to 12% faster than the previous generation.
- CASE adds a Variable Geometry Turbocharger to ensure a fast transient response of the engine while minimizing fluid consumption.

PRODUCTIVITY BIGGER PERFORMANCE



HIGH EFFICIENCY: THE SECRET

Great performances with low fuel consumption

CASE Intelligent Hydraulic System (CIHS) reads continuously the load pressure through strategic sensors and like an ORCHESTRA DIRECTOR gives always and in real time the right balance for any type of job, providing solid fuel saving opportunities. It consists of 6 Energy Saving controls:

- Torque control decreases main pump loads to prevent a drop in engine rpm.
- Boom Economy Control (BEC) increased fuel efficiency during boom lower and swing operations.
- Swing Relief Control (SWC) carefully manages the hydraulic power distribution in slewing operations.
- Spool Stroke Control (SSC) creates an automatic pressure adjustment during digging and leveling operations.
- The Auto Idle and the Idle Shutdown functions avoid unnecessary fuel consumption.
- Boom Oil Reigenation (BOR) uses the boom down movement to make arm opening faster with pump power saving.



CLEANER (STAGE V)

EU Stage V compliant CASE engines

- The new STAGE V engine meets the latest EU standards for engine exhaust emissions that sets new limit for particle number (PN) and further reduced particulate matter (PM) levels.
- Water separator sensor linked to a dedicated message on machine monitor to drain water when level in filter is too high.
- New safety filter (maintenance free) to protect the engine from dust during the main filter replacement.
- The closed circuit ventilation system makes sure the oil gas are filtered, separated and sent back to the crankcase, avoiding dispersion into the air.
- The engine of the latest generation, electronically controlled with Variable Geometry Turbocharger, high pressure common rail with multi-injection ensures great performances and low fuel consumption.
- Largest Adblue® tank in the industry allows longer working time without stopping for Adblue refill (8-10 fuel refills before a stop). With CASE no time is wasted and your refill is more efficient and safe.

D-SERIES CRAWLER EXCAVATORS



COMFORTABLE AND SAFE CAB

Ergonomic seat design and spacious cab

- Superior cab structure with ample legroom for the operator.
- Fully adjustable workstation.
- New ergonomically designed highback seat with air suspension for excellent comfort.
- Optional seat tilting adjustment and seat heater.
- Top class features include 178 mm colour LED Monitor, bluetooth tuner and Radio, spacious storage compartment, 12v accessory plug, clipboard holder, mobile phone holder, warm and cool box, fuse box service connection, storage tray and ergonomic arm rest.
- Reinforced structure of the cab compliant with ROPS/FOPS requirements.
- Standard head protection approved to FOPS Level 2.
- Wide offering of optional front guards.
- Optional factory fitted travel alarm for greater safety on the jobsite around the machine.



OUTSTANDING VISIBILITY & QUIET WORK ENVIRONMENT

- Outstanding visibility with ample glazed surface, right and rear camera.
- Soundproof pressurised cab.
- The cushioning system lowers noise and vibration levels for the operator's ultimate comfort.



COMFORT RULES FIRST CLASS CAB AND SEAT



D-SERIES CRAWLER EXCAVATORS



CASE MAXIMUM VIEW MONITOR

option with its bird's eye and panoramic view improves operator's safety by:

- 270° wide vision.
- 3 cameras.
- 7 inch full color monitor.
- Blind spots eliminated by image processing.
- Led lighting package LED lights for increased visibility in low light conditions.
- Safety on the jobsite around the machine.



HEAVY DUTY APPLICATION

CX370D MONO

- The mono version CX370D is equipped as standard with heavier counterweight, full track guide and a special heavy duty attachment, Heavy Duty boom & HD arm with reinforcement plate and bars on the bottom side with high-tensile strength steel for long term durability to work in the toughest heavy duty applications.



SAFETY AND MAINTENANCE

WORK SAFELY IN ALL CONDITIONS



SAFE ACCESS TO UPPERCARRIAGE

Solid and robust platform and handrails

- Wide, robust and comfortable steps or safe access to the top of the hood.
- Solid handrail for protection on the top of the hood.
- Non slip-plates and top hood cover supported by 2 gas pistons and secured by 2 mechanical stops when open.
- A wide platform (up to 60 cm) on top of the engine compartment to work safely on the engine box.



EASY MAINTENANCE

CASE stays «grounded»

- All filters and regular fill points are grouped for easy access.
- Engine oil change intervals set at 500 hours.
- Radiator and cooler cores mounted side by side for easy access for cleaning and more efficient cooling.
- Standard 100 l/min refueling pump with automatic cut off reduces downtime for regular fills.
- Optional hydraulic and engine oil sampling port accessible at ground level for easy oil check.
- Battery Shutdown Switch for safe maintenance on the electrical system.
- All the D-series crawler excavators feature the Extended Maintenance System (EMS) bushings, providing 1,000 hour greasing intervals on all pins except the attachment linkage.



MAIN REASONS TO CHOOSE THE D-SERIES



THE SECRET FOR HIGH PRECISION AND CONTROLLABILITY

is the CASE Intelligent Hydraulics System (CIHS) which is the result of continuous pursuit of perfection of a legendary brand. CASE is synonymous and reference in the market for its fastest cycles times, best energy saving performance and smooth control



HIGH EFFICIENCY

- Energy saving system to take advantage of all fuel saving opportunities: up to 8% more fuel efficiency
- Largest AdBlue tank in the industry (152 litres). Your refill is more efficient and safe



HIGH VERSATILITY

- With the 2-PIECE BOOM OPTION available on CX370D, CASE can now offer an extra versatility
- 3 available power modes to match customers needs (A, H, SP)
- Auto Power boost job-sensing hydraulic pressure increase



FAST CYCLES

- New electronically controlled hydraulic pumps
- New larger main valve





OUTSTANDING VISIBILITY

- Wide glazed area
- Rear and side view cameras
- Large LED monitor
- Optional LED lighting package



SMOOTH RIDE, QUIET WORK ENVIRONMENT

- Cab with cushioning system
- Low noise and vibration



COMFORTABLE AND SAFE CAB

- ROPS cab and FOPS level II
- Extra spacious cab
- Fully adjustable workstation
- New high back seat



STAGE V ENGINE

in line with the latest EU standard for engine exhaust emissions

- new ATS with DPD filter (Diesel Particulate Diffuser)
- new closed PCV system (Positive Crankcase Ventilation)



SAFE OPERATION AND MAINTENANCE

- New Fuel filter supply line with no need to flush after filter replacement: thanks to a safety filter (maintenance free)
- Fuel prefilter Water sensor with dedicated message on Cabin monitor
- Standard extended handrails
- Optional factory fitted travel alarm
- Maintenance points grouped for easy and safe access



HIGH RELIABILITY

Reliability and durability thanks to the new redesigned arm, boom and undercarriage





THE SCIENCE BIT

The CASE SiteWatch telematics system uses a high-tech control unit mounted on each machine to collate information from that machine and from GPS satellites. This data is then sent wirelessly through the mobile communication networks to the CASE Telematics Web Portal.



SiteWatch: centralised fleet control benefits at your fingertips

📶 Measure your true asset availability and optimise it

- Eliminate the “phantom fleet”: SiteWatch allows to identify spare units or under loaded machines on each site.
- Become able to reallocate units where they are more needed.
- Forward Maintenance Planning is easier since the actualised working hours are always available.
- Extend the benefits of SiteWatch to the rest of your fleet: SiteWatch can be installed on the units of other brands as well.

📶 Challenge your Total Cost of Ownership!

- Being able to compare the fuel usage of different machine types will allow you choose the right equipment.
- Save on transport costs with planned and grouped maintenance tasks.
- Peace of mind, optimised uptime and lower repair costs: with preventive maintenance you can for example be alerted if the engine needs to be serviced and avoid a disruptive breakdown.
- Be able to compare your asset Return On Investment on different sites.
- Your equipment is used only during working hours. You can set up alerts so that you know if it is in use during the weekend or at night.
- Integrate with the programmed maintenance package, so that you can be sure every machine is at the right place at the right time.

📶 More Safety, Lower Insurance Premium

- Keep thieves away: dissuade them from attacking your asset because it is geo-localised. SiteWatch is hidden so that thieves can't find it quickly.
- Your fleet is used only where you decide. You can define a virtual fence and receive an email when a machine exits that perimeter.

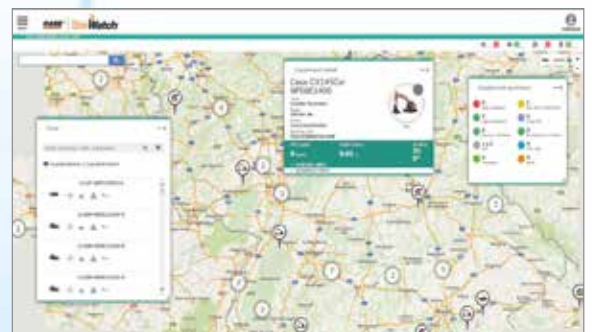

STANDARD AND OPTIONS

STANDARD EQUIPMENT

ENGINE

Isuzu 6-cylinder turbo-charged diesel
EU stage V Certified
Selective Catalytic Reduction (SCR)
Diesel Oxidation Catalyst (DOC)
Cooled Exhaust Gas Recirculation (CEGR)
Diesel Particulate Diffuser (DPD)
VGT turbocharger
Electronic fuel injection
High pressure common rail system
Neutral safety start
Auto-engine warm up, emergency stop
Glow-plug pre-heat
Engine Protection Feature (EPF)
Dual-stage fuel filtration
Dual element air filter
Remote oil filter
Green plug oil drain
500-hour engine oil change interval
24-Volt system
Battery disconnect switch
External Fuel and AdBlue gauges
Fuel cooler
Fuel filter restriction indicator
Fuel prefilter Water sensor with dedicated message on Cabin monitor
Idle start
Radiator, oil cooler, intercooler – protective Screen
Refueling Pump

FUEL ECONOMY SYSTEMS

Engine Idle/Fuel Economy System:
Auto-idle
One-touch idle
Auto-idle shut-down
Torque control
Boom Economy Control (BEC)
Swing Relief Control (SWC)
Spool Stroke Control (SSC)

OPTIONAL EQUIPMENT

HYDRAULICS

Low-flow circuit, proportional control
Single acting pedal activated hammer circuit
Single acting hammer circuit with electrical proportional control
Multifunction (hammer/high flow) circuit with electrical proportional control

ATTACHMENTS

Arm - 2.20/2.63/4.05 m (CX350D)
Arm - 2.63 (CX370D 2PB)
HD Arm - 2.20/2.63 (CX370D)
Hydraulic quick coupler provision
Safety valves and bucket linkage with hook

HYDRAULICS

Electronically controlled hydraulic pumps
Auto power boost
Auto travel speed change
Selectable work modes
Overload warning device
ISO pattern controls
Pre-set auxiliary pump settings
Switch controlled auxiliary selection
Auxiliary valve
Hydraulic filter restriction indicator
Oil cooler
5,000 hour hydraulic oil change interval
2,000 hour hydraulic filter change interval

UPPERSTRUCTURE

ISO mirrors
Handrail and
Isolation mounted cab (fluid and spring)
Lifting eyes for counterweight
Lockable fuel cap, service doors and toolbox
Rear and side view safety camera

OPERATOR STATION

ROPS protection
FOPS guard OPG level II
Pressurized cab
Tempered safety glass
One-touch lock front window
Sun visor&rain deflector
AC/heat/defrost w/auto climate control
Hot&coolbox, cup holder & ashtray
Interior dome light
Cloth covered air-suspension high-back seat
Sliding seat – 90 mm
Seat-belt
Adjustable armrests
Tilting consoles - 4-position
Low-effort joystick controls

OPERATOR STATION

Front cab guard - vertical bars (OPG level 2)
Front cab guard - vertical bars (OPG level 1)
Front mesh screen
Travel alarm
AM/FM CD/radio with antenna and 2-speakers
LED working lights
LED lights (8 lights included side view camera with LED lights)
Case Maximum View Monitor (CMVM) - 3 cameras system
Side view camera with LED lights (right and left)

UNDERCARRIAGE (for all models and versions)

700 mm steel triple grouser shoes

Sliding cockpit 180 mm
Auxiliary select system
Aux-in port for personal electronics
Multifunction LED color monitor (180 mm)
26 selectable languages for monitor
Anti-theft system (start code system)
Rubber floor mat
12-volt electric socket
24-volt cigarette lighter
One-piece right hand window
Working lights (boom&upperstructure)
Cab top working lights
Windshield wiper / washer
Clear (Lexan) roof window w/sunshade
Storage compartments
On-board diagnostic system

ATTACHMENTS

Standard boom 6.45m (CX350D)
HD boom 6.45m (CX370D)
Arm 3.25 (CX350D)
HD arm 3.25 (CX370D) with reinforcement plate and bars
Auxiliary pipe brackets with guard bar
Centralized lube bank
Attachment cushion valve

FOR 2PB

1st Boom length 3460 mm
2nd Boom length 3100 mm
arm 3.25

UNDERCARRIAGE

600 mm steel triple grouser shoes
Full overlap turntable bearing tub
Sealed link chain
Lashing points
Double track guide (CX350D, CX370D 2PB)
Full track guide (CX370D)

800 mm steel triple grouser shoes
900 mm steel triple grouser shoes (only for CX350 LC)
Full track guide (CX350D/CX370D 2PB)
Double (CX370D MONO)

TELEMATICS

Three years SiteWatch “Advanced” subscription with remote monitoring and one user’s licence

OTHERS

Engine and hydraulic oil sampling ports
Retractable roller screen option available for rear cab window (as DIA kit only)

CX D-SERIES

CX350D - CX370D

ENGINE

Model _____ ISUZU VE-6HK1X
 Type _____ Water-cooled, 4-cycle diesel, 6-cylinder in line,
 High pressure common rail system (electric control), Turbocharger
 with air cooled intercooler, SCR system & DPD system.
 Emission level _____ REG. EU 2016/1628 STAGE V
 Number of cylinders / Displacement (l) _____ 6 / 7,79
 Bore & stroke (mm) _____ 115 x 125
 Rated flywheel horse power
 SAE J1349, ISO 9249 _____ 200 kW / 268 hp at 1900 min⁻¹
 ISO 14396 _____ 210 kW / 282 hp at 1900 min⁻¹
 Maximum torque
 SAE J 1349, ISO 9249 _____ 988 N-m at 1500 min⁻¹
 ISO 14396 _____ 1020 N-m at 1500 min⁻¹

HYDRAULIC SYSTEM

Main pumps _____ 2 variable displacement axial piston pumps with
 regulating system
 Max. oil flow _____ 2 x 300 liter/min at 1900 min⁻¹

Working circuit pressure

Boom/Arm/Bucket (MPa) _____ 34.3 - 37.3 with auto power boost
 Swing circuit (MPa) _____ 30.4
 Travel circuit (MPa) _____ 34.3
 Pilot pump (l/min) _____ 28.5
 Working circuit pressure (MPa) _____ 3.9

Boom Cylinders

Bore (mm) _____ 145
 Stroke (mm) _____ 1495

Boom Positioning (2 piece boom only)

Bore (mm) _____ 170
 Stroke (mm) _____ 1335

Arm Cylinder

Bore (mm) _____ 170
 Stroke (mm) _____ 1748

Bucket Cylinder

Bore (mm) _____ 150
 Stroke (mm) _____ 1210

PERFORMANCE DATA CX350D/CX370D

		Arm 3.25 m	Arm 2.20 m	Arm 2.63 m	Arm 4.05 m*
Boom length	mm	6450	6450	6450	6450
Bucket radius	mm	1680	1680	1680	1680
Bucket wrist action		173°	173°	173°	173°
A Maximum reach at GRP	mm	10980	9970	10450	11710
B Maximum reach	mm	11170	10180	10650	11900
C Max. digging depth	mm	7340	6300	6720	8140
D Max. digging height	mm	10380	9830	10280	10650
E Max. dumping height	mm	7240	6730	7110	7530
F Min. swing radius	mm	4510	4410	4440	4530

DIGGING FORCE (ISO 6015)

		Arm 3.25 m	Arm 2.20 m	Arm 2.63 m	Arm 4.05 m*
Arm digging force	kN	164.5	225.3	194.7	140.0
with Auto power boost	kN	178.8	245.0	211.7	152.2
Bucket digging force	kN	229.7	229.7	229.7	229.7
with Auto power boost	kN	249.8	249.8	249.8	249.8

*CX350D only

SWING

Swing Motor _____ Fixed displacement axial piston motor
 Maximum swing speed _____ 9.7 min⁻¹
 Swing torque (Nm) _____ 112,000

FILTERS

Suction filter (µm) _____ 105
 Return filter (µm) _____ 6
 Pilot line filter (µm) _____ 8

ELECTRICAL SYSTEM

Voltage (V) _____ 24
 Alternator (Amp) _____ 90
 Starter (V/kW) _____ 24/5.0
 Battery _____ 2X12V - 128 Ah/5 HR

UNDERCARRIAGE

Travel motor _____ Variable displacement axial piston motor
 High travel speed (Automatic travel speed shifting) (km/h) _____ 5.5
 Low travel speed (km/h) _____ 3.3
 Drawbar pull (kN) _____ 273
 Number of carrier rollers (each side) _____ 2
 Number of track rollers (each side) _____ 8
 Number of shoes (each side) _____ 48
 Type of shoes _____ Triple grouser shoes
 Grade ability _____ 70 % (35°)

SOUND LEVEL

External guaranteed sound level
 (EU Directive 2000/14/EC) _____ LwA 105 dB(A)
 Operator cab sound pressure level (ISO 6396) _____ LpA 71 dB(A)

CIRCUIT AND COMPONENT CAPACITIES

Fuel tank (l) _____ 580
 Hydraulic system (l) _____ 350
 Hydraulic tank (l) _____ 175
 Adblue tank (l) _____ 152

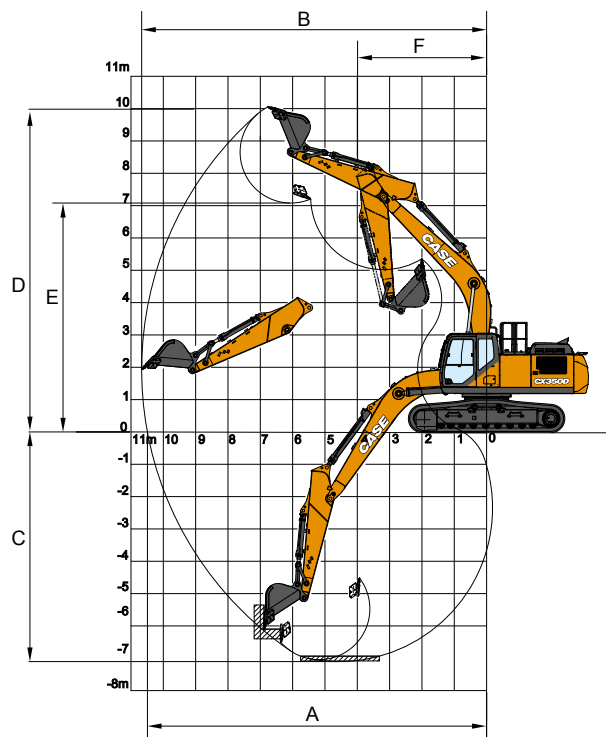

GENERAL DIMENSIONS MONO LC-NLC

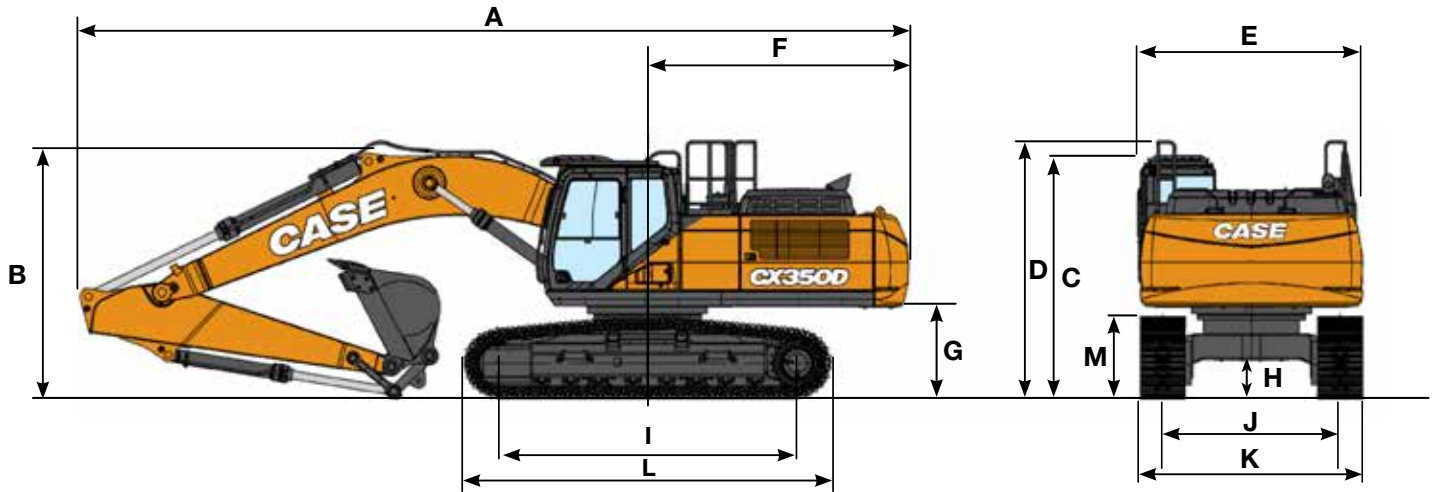

LC/NLC		Arm 3.25 m	Arm 2.20 m	Arm 2.63 m	Arm 4.05 m*
Overall length (without attachment)	mm	6010	6010	6010	6010
A Overall length (with attachment)	mm	11170	11250	11220	11190
B Overall height (to top of boom)	mm	3470	3620	3630	3620
C Cab height	mm	3260	3260	3260	3260
D Overall height (to top of hand rail)	mm	3470	3470	3470	3470
E Upper structure overall width	mm	3030	3030	3030	3030
F Swing (rear end radius)	mm	3550	3550	3550	3550
G Clearance height under upper structure	mm	1210	1210	1210	1210
H Minimum ground clearance	mm	470	470	470	470
I Wheel base (Center to center of wheels)	mm	4040	4040	4040	4040
L Crawler overall length	mm	4980	4980	4980	4980
M Crawler tracks height	mm	1090	1090	1090	1090

LC		Arm 3.25 m	Arm 2.20 m	Arm 2.63 m	Arm 4.05 m*
J Track gauge	mm	2600	2600	2600	2600
K Undercarriage overall width (with 600 mm shoes)	mm	3200	3200	3200	3200

NLC		Arm 3.25 m	Arm 2.20 m	Arm 2.63 m	Arm 4.05 m*
J Track gauge	mm	2390	2390	2390	2390
K Undercarriage overall width (with 600 mm shoes)	mm	2990	2990	2990	2990

*CX350D only

WEIGHT AND GROUND PRESSURE CX350D

With 3.25 m Arm, 1.54 m³ Heavy Duty bucket, 600 mm grouser shoes, operator, fluids, full fuel tank, and FOPS level 2 guard.

CX350D LC	Weight	Ground pressure
	36150 kg	0.067 MPa

CX350D NLC	Weight	Ground pressure
	36050 kg	0.067 MPa

Counterweight 6.400 kg

WEIGHT AND GROUND PRESSURE CX370D

With 3.25 m Heavy Duty Arm, 1.75 m³ Heavy Duty bucket, 600 mm grouser shoes, operator, fluids, full fuel tank, and FOPS level 2 guard.

CX370D LC	Weight	Ground pressure
	38200 kg	0.071 MPa

CX370D NLC	Weight	Ground pressure
	38100 kg	0.071 MPa

Counterweight 7.400 kg

CX D-SERIES

CX370D 2 PIECE BOOM

GENERAL DIMENSIONS

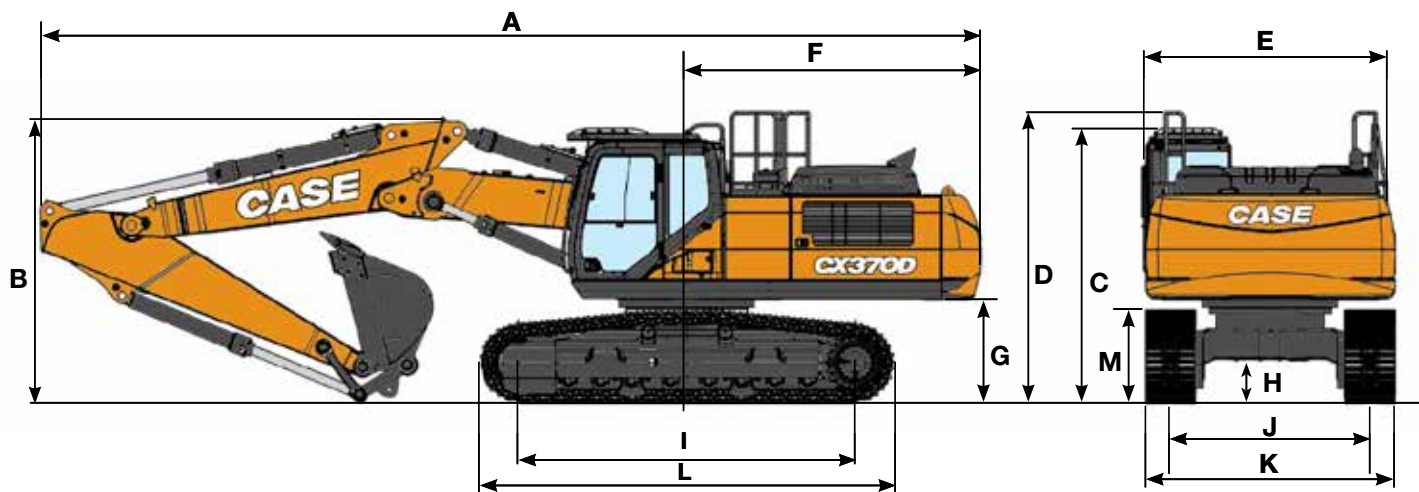

LC/NLC		Arm 3.25 m	Arm 2.63 m
	Overall length (without attachment)	mm	6010
A	Overall length (with attachment)	mm	11270
B	Overall height (to top of boom)	mm	3400
C	Cab height	mm	3260
D	Overall height (to top of hand rail)	mm	3360
E	Upper structure overall width	mm	3030
F	Swing (rear end radius)	mm	3550
G	Clearance height under upper structure	mm	1210
H	Minimum ground clearance	mm	470
I	Wheel base (Center to center of wheels)	mm	4040
L	Crawler overall length	mm	4980
M	Crawler tracks height	mm	1090
J	Track gauge	mm	2600
K	Undercarriage overall width (with 600 mm shoes)	mm	3200 / 2990

WEIGHT AND GROUND PRESSURE CX370D 2 PIECE BOOM

With 3.25 m Arm, 1.54 m³ Heavy Duty bucket, 600 mm grouser shoes, operator, fluids, full fuel tank, and FOPS level 2 guard.

CX370D LC	Weight	Ground pressure
	38450 kg	0.072 MPa

CX370D NLC	Weight	Ground pressure
	38350 kg	0.072 MPa

Counterweight 7.400 kg

PERFORMANCE DATA

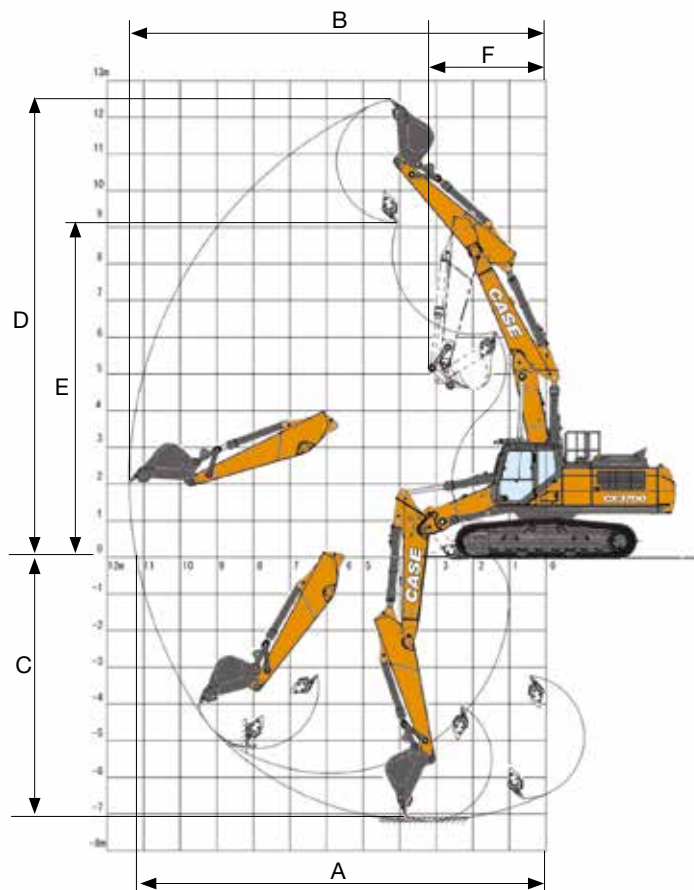

LC/NLC		Arm 3.25 m	Arm 2.63 m
1 st boom length	mm	3460	3460
2 nd boom length	mm	3100	3100
Bucket radius	mm	1680	1680
Bucket wrist action	°	173	173
A Maximum reach at GRP	mm	11200	10640
B Maximum reach	mm	11390	10840
C Max. digging depth	mm	7190	6600
D Max. digging height	mm	12470	12110
E Max. dumping height	mm	9130	8750
F Min. swing radius	mm	3520	3520

DIGGING FORCE (ISO 6015)

		Arm 3.25 m	Arm 2.63 m
Arm digging force	kN	164.5	194.7
with Auto power boost	kN	178.8	245.0
Bucket digging force	kN	229.7	229.7
with Auto power boost	kN	249.8	249.8

LIFTING CAPACITY

CX350D MONO

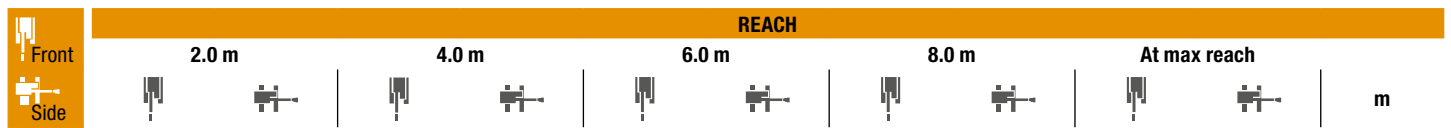

LC UNDERCARRIAGE - Standard arm 3.25 m, 600 mm shoes, max reach 9.49 m

Height	2.0 m	4.0 m	6.0 m	8.0 m	At max reach	Reach (m)					
8.0 m											
6.0 m				8680*	6690	6360*	5870	8.62			
4.0 m		16200*	16200*	11230*	9950	9290*	6450	6400*	5070	9.29	
2.0 m		14670*	14670*	13260*	9200	9280	6130	6810*	4760	9.49	
0 m			15610*	15610*	13850	8710	9010	5880	7320	4820	9.26
-2.0 m	12600*	12600*	20870*	15670	13670	8550	8930	5810	8150	5340	8.56
-4.0 m	23180*	23180*	17350*	16020	12140*	8710			9280*	6790	7.27

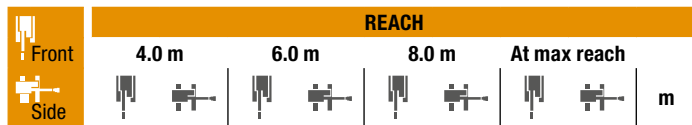

LC UNDERCARRIAGE
Short arm 2.63 m, 600 mm shoes, max reach 8.97 m

Height	4.0 m	6.0 m	8.0 m	At max reach	Reach (m)			
8.0 m				9730*	8820	6.68		
6.0 m	10230*	10230*	9390*	6480	8990*	6410	8.05	
4.0 m	11930*	6890	9480	6300	8190	5450	8.76	
2.0 m	13710*	8970	9170	6020	7720	5100	8.97	
0 m		13700	8580	8950	5820	7930	5200	8.73
-2.0 m	19540*	15690	13640	8520		9020	5870	7.98
-4.0 m	15300*	15300*	10760*	8830		9220*	7870	6.57

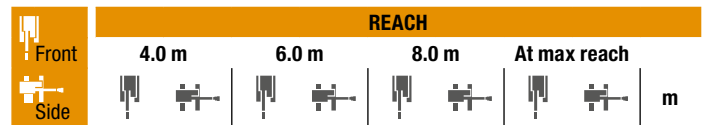

LC UNDERCARRIAGE
S-Short arm 2.20 m, 600 mm shoes, max reach 8.50 m

Height	4.0 m	6.0 m	8.0 m	At max reach	Reach (m)			
8.0 m		10650*	10480*		10650*	10370	6.04	
6.0 m		10870*	10290		10070*	7160	7.52	
4.0 m		12490*	9620	9480	6310	8970	5980	8.28
2.0 m		14110*	8970	9210	6060	8420	5570	8.5
0 m		13770	8650	9050	5920	8680	5700	8.25
-2.0 m	18570*	15950	13530*	8660		10060	6550	7.45
-4.0 m	13880*	13880*				9700*	9290	5.91

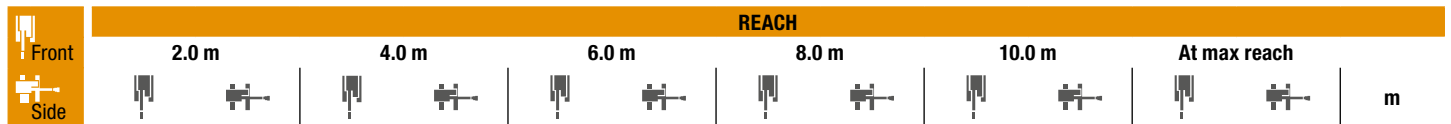

LC UNDERCARRIAGE - Long arm 4.05 m, 600 mm shoes, max reach 10.20 m

Height	2.0 m	4.0 m	6.0 m	8.0 m	10.0 m	At max reach	Reach (m)						
8.0 m				6160*	6160*		4960*	4960*	8.28				
6.0 m				7660*	6760		4710*	4710*	9.42				
4.0 m				9960*	9960*	8430*	6450	4950*	4430	4750*	4410	10.03	
2.0 m		19200*	16750	12200*	9240	9240	6060	6530	4290	5020*	4140	10.22	
0 m			17890*	15490	13750	8590	8880	5740	5620*	4160	5590*	4160	10
-2.0 m	11300*	11300*	21500*	15220	13420	8300	8700	5580		6700*	4520	9.36	
-4.0 m	18830*	18830*	18900*	15430	12980*	8340	8790	5660		8520	5500	8.19	
-6.0 m			13350*	13350*	8660*	8660*				8150*	8150*	6.19	

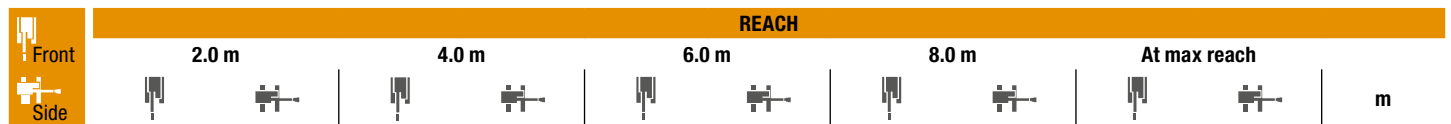

NLC UNDERCARRIAGE - Standard arm 3.25 m, 600 mm shoes, max reach 9.49 m

Height	2.0 m	4.0 m	6.0 m	8.0 m	At max reach	Reach (m)					
8.0 m											
6.0 m				8680*	6190	6360*	5420	8.62			
4.0 m		16200*	16200*	11230*	9170	9290*	5950	6400*	4670	9.29	
2.0 m		14670*	14670*	13260*	8430	9260	5630	6810*	4370	9.49	
0 m			15610*	14090	13820	7950	8990	5390	7300	4420	9.26
-2.0 m	12600*	12600*	20870*	14090	13640	7800	8920	5320	8130	4890	8.56
-4.0 m	23180*	23180*	17350*	14430	12140*	7960			9280*	6230	7.27

* The above loads (kg) are compliant to the ISO standards and refer to the excavator equipped without bucket. The indicated loads are no more than 87% of hydraulic system lift capacity or 75% of static tipping load. Values marked with an asterisk (*) are limited by the hydraulic lifting capacity.

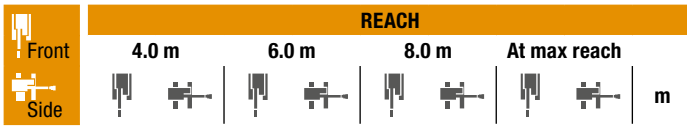

NLC UNDERCARRIAGE

Short arm 2.63 m, 600 mm shoes, max reach 8.97 m

8.0 m							9730*	8160	6.68
6.0 m			10230*	9580	9390*	5990	8990*	5920	8.05
4.0 m			11930*	8900	9460	5810	8170	5020	8.76
2.0 m			13710*	8210	9150	5530	7710	4680	8.97
0 m			13680	7820	8940	5340	7910	4770	8.73
-2.0 m	19540*	14120	13610	7770			900	5380	7.98
-4.0 m	15300*	14570	10760*	8070			9220*	7220	6.57

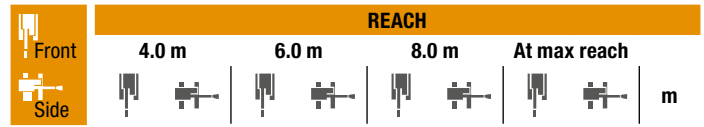

NLC UNDERCARRIAGE

S-Short arm 2.20 m, 600 mm shoes, max reach 8.50 m

8.0 m			10650*	9690			10650*	9590	6.04
6.0 m			10870*	9500			10070*	6610	7.52
4.0 m			12490*	8850	9460	5810	8960	5510	8.28
2.0 m			14110*	8210	9190	5570	8400	5120	8.5
0 m			13740	7900	9030	5430	8660	5230	8.25
-2.0 m	18570*	14360	13530*	7910			10040	6010	7.45
-4.0 m	13880*	13880*					9700	8500	5.91

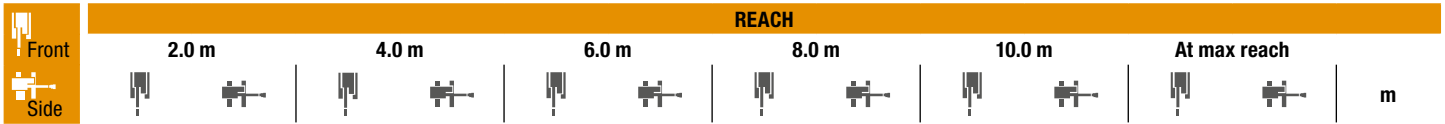

NLC UNDERCARRIAGE - Long arm 4.05 m, 600 mm shoes, max reach 10.20 m

8.0 m							6160*	6160*			4960*	4960*	8.28	
6.0 m							7660*	6250			4710*	4650	9.42	
4.0 m						9960*	9320	8430*	5950	4950*	4070	4750*	4050	10.03
2.0 m			19200*	15120	12200*	8470	9220	5570	6520	3930	5020*	3790	3790	10.22
0 m			17890*	13910	13720	7830	8860	5250	5620*	3800	5590*	3800	3800	10
-2.0 m	11300*	11300*	21500*	13650	13390	7550	8680	5090			6700*	4130	4130	9.36
-4.0 m	18830*	18830*	18990*	13860	12980*	7580	8780	5170			8510	5030	5030	8.19
-6.0 m			13350*	13350*	8660*	8040					8150*	7720	7720	6.19

CX350D LC

HEAVY DUTY BUCKET (DIRECT MOUNT)

CAPACITY m ³ (ISO7451 HEAPED)	WIDTH mm	WEIGHT kg	ARM 3.25 m	ARM 2.63 m	ARM 2.20 m	ARM 4.05 m
0.91	900	1213	○	○	○	○
1.19	1100	1338	○	○	○	○
1.33	1200	1439	○	○	○	●
1.54	1350	1533	●	○	○	■
1.75	1500	1666	■	●	●	■
2.03	1700	1829	■	■	●	×
2.17	1800	1894	×	■	■	×

HEAVY DUTY SCOOP BUCKET (WITH CASE MULTI-FIT S COUPLER)

CAPACITY m ³ (ISO7451 HEAPED)	WIDTH mm	WEIGHT kg	ARM 3.25 m	ARM 2.63 m	ARM 2.20 m	ARM 4.05 m
0.91	900	1188	○	○	○	○
1.19	1100	1316	○	○	○	●
1.33	1200	1418	●	○	○	■
1.54	1350	1514	■	●	●	×
1.75	1500	1648	■	■	●	×
2.03	1700	1801	×	×	■	×

ROCK BUCKET (DIRECT MOUNT)

CAPACITY m ³ (ISO7451 HEAPED)	WIDTH mm	WEIGHT kg	ARM 3.25 m	ARM 2.63 m	ARM 2.20 m	ARM 4.05 m
0.91	900	1254	○	○	○	○
1.19	1100	1382	○	○	○	○
1.33	1200	1480	○	○	○	●
1.54	1350	1576	●	○	○	■
1.75	1500	1706	■	●	●	■
2.03	1700	1872	■	■	■	×
2.17	1800	1939	×	■	■	×

ROCK SCOOP BUCKET (WITH CASE MULTI-FIT S COUPLER)

CAPACITY m ³ (ISO7451 HEAPED)	WIDTH mm	WEIGHT kg	ARM 3.25 m	ARM 2.63 m	ARM 2.20 m	ARM 4.05 m
0.91	900	1188	○	○	○	○
1.19	1100	1316	○	○	○	●
1.33	1200	1418	●	●	○	■
1.54	1350	1514	■	●	●	×
1.75	1500	1648	■	■	■	×
2.03	1700	1801	×	×	■	×

CX350D NLC

HEAVY DUTY BUCKET (DIRECT MOUNT)

CAPACITY m ³ (ISO7451 HEAPED)	WIDTH mm	WEIGHT kg	ARM 3.25 m	ARM 2.63 m	ARM 2.20 m	ARM 4.05 m
0.91	900	1220	○	○	○	○
1.19	1100	1340	○	○	○	●
1.33	1200	1440	○	○	○	●
1.54	1350	1540	●	●	○	■
1.75	1500	1670	■	■	●	×
2.03	1700	1830	×	■	■	×
2.17	1800	1900	×	×	■	×

ROCK BUCKET (DIRECT MOUNT)

CAPACITY m ³ (ISO7451 HEAPED)	WIDTH mm	WEIGHT kg	ARM 3.25 m	ARM 2.63 m	ARM 2.20 m	ARM 4.05 m
0.91	900	1260	○	○	○	○
1.19	1100	1390	○	○	○	●
1.33	1200	1480	●	○	○	■
1.54	1350	1580	●	●	○	■
1.75	1500	1710	■	■	●	×
2.03	1700	1880	×	■	■	×
2.17	1800	1940	×	×	■	×

○ Rated material density up to 2 ton/m³ ● Rated material density up to 1.6 ton/m³ ■ Rated material density up to 1.2 ton/m³ × Not applicable

LIFTING CAPACITY

CX370D MONO

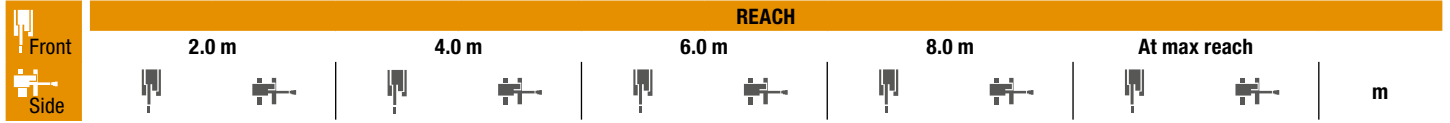

LC UNDERCARRIAGE - Standard arm 3.25 m, 600 mm shoes, max reach 9.49 m

Height (m)	2.0 m	4.0 m	6.0 m	8.0 m	At max reach	Capacity (kg)	Capacity (kg)	Capacity (kg)	Capacity (kg)	Capacity (kg)	
8.0 m									6670*	6670*	7.37
6.0 m						8430*	7070		6270*	6190	8.62
4.0 m			15840*	15840*	10940*	10540	9010*	6800	6320*	5330	9.29
2.0 m			14610*	14610*	12890*	9710	9770	6450	6720*	4990	9.49
0 m			15540*	15540*	14010*	9160	9480	6180	7580*	5050	9.26
-2.0 m	12520*	12520*	20280*	16530	13800*	9000	9390	6100	8560	5600	8.56
-4.0 m	23110*	23110*	16800*	16800*	11740*	9180			8930*	7150	7.27

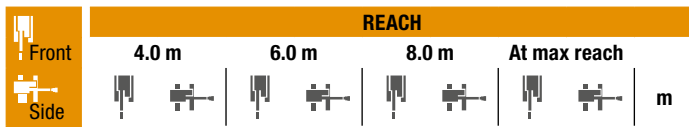

LC UNDERCARRIAGE
Short arm 2.63 m, 600 mm shoes, max reach 8.97 m

Height (m)	4.0 m	6.0 m	8.0 m	At max reach	Capacity (kg)	Capacity (kg)	Capacity (kg)	Capacity (kg)
8.0 m					9680*	9460		6.68
6.0 m		10130*	10130*	9270*	6960	8950*	6890	8.05
4.0 m		11800*	10400	9610*	6770	8740	5860	8.76
2.0 m		13550*	9660	9790	6480	8250	5480	8.97
0 m		14290*	9240	9570	6270	8470	5590	8.73
-2.0 m	19270*	16890	13590*	9180		9550*	6320	7.98
-4.0 m	15060*	15060*	10570*	9490		9060*	8460	6.57

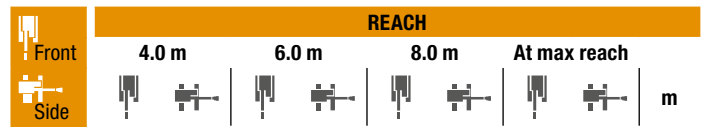

LC UNDERCARRIAGE
S-Short arm 2.20 m, 600 mm shoes, max reach 8.50 m

Height (m)	4.0 m	6.0 m	8.0 m	At max reach	Capacity (kg)	Capacity (kg)	Capacity (kg)	Capacity (kg)	Capacity (kg)		
8.0 m					10540*	10540*			10550*	10550*	6.04
6.0 m					10760*	10760*			9940*	7680	7.52
4.0 m					12360*	10340	10020*	6770	9580	6420	8.28
2.0 m					13930*	9650	9830	6520	8990	5980	8.5
0 m					14390*	9310	9660	6360	9270	6120	8.25
-2.0 m	18300*	17140	13330*	9320					10250*	7040	7.45
-4.0 m	13630*	13630*							9520*	9520*	5.91

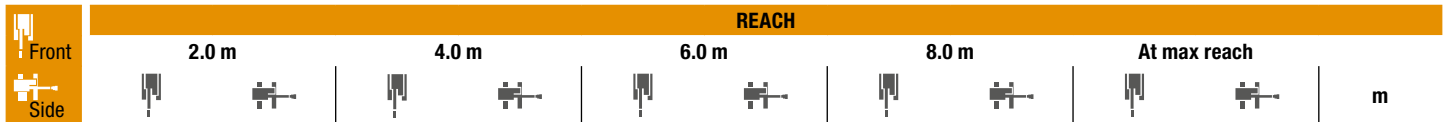

NLC UNDERCARRIAGE - Standard arm 3.25 m, 600 mm shoes, max reach 9.49 m

Height (m)	2.0 m	4.0 m	6.0 m	8.0 m	At max reach	Capacity (kg)	Capacity (kg)	Capacity (kg)	Capacity (kg)	Capacity (kg)	
8.0 m									6670*	6670*	7.37
6.0 m							8430*	6550	6270*	5720	8.62
4.0 m			15840*	15840*	10940*	9720	9010*	6280	6320*	4910	9.29
2.0 m			14610*	14610*	12890*	8900	9750	5930	6720*	4590	9.49
0 m			15540*	14860	14010*	8370	9460	5660	7580*	4640	9.26
-2.0 m	12520*	12520*	20280*	14870	13800*	8210	9370	5590	8550	5140	8.56
-4.0 m	23110*	23110*	16800*	15260	11740*	8380			8930*	6560	7.27

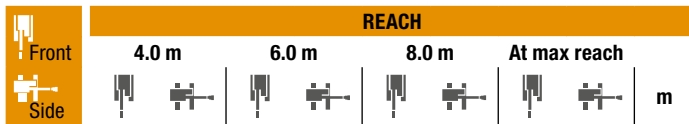

NLC UNDERCARRIAGE
Short arm 2.63 m, 600 mm shoes, max reach 8.97 m

Height (m)	4.0 m	6.0 m	8.0 m	At max reach	Capacity (kg)	Capacity (kg)	Capacity (kg)	Capacity (kg)
8.0 m					9680*	8760		6.68
6.0 m		10130*	10130*	9270*	6440	8950*	6370	8.05
4.0 m		11800*	9580	9610*	6250	8730	5400	8.76
2.0 m		13550*	8860	9770	5960	8230	5050	8.97
0 m		14290*	8450	9550	5760	8450	5140	8.73
-2.0 m	19270*	15220	13590*	8390		9550*	5810	7.98
-4.0 m	15060*	15060*	10570*	8690		9060*	7770	6.57

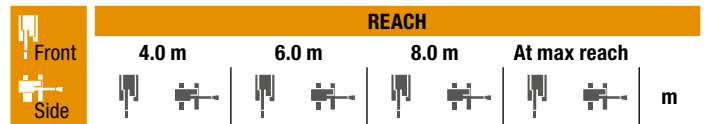

NLC UNDERCARRIAGE
S-Short arm 2.20 m, 600 mm shoes, max reach 8.50 m

Height (m)	4.0 m	6.0 m	8.0 m	At max reach	Capacity (kg)	Capacity (kg)	Capacity (kg)	Capacity (kg)	Capacity (kg)		
8.0 m					10540*	10400			10550*	10290	6.04
6.0 m					10760*	10210			9940*	7110	7.52
4.0 m					12360*	9520	10020*	6260	9560	5930	8.28
2.0 m					13930*	8850	9810	6000	8970	5510	8.5
0 m					14390*	8510	9640	5850	9250	5640	8.25
-2.0 m	18300*	15470	13330*	8520					10250*	6470	7.45
-4.0 m	13630*	13630*							9520*	9150	5.91

* The above loads (kg) are compliant to the ISO standards and refer to the excavator equipped without bucket. The indicated loads are no more than 87% of hydraulic system lift capacity or 75% of static tipping load. Values marked with an asterisk (*) are limited by the hydraulic lifting capacity.

LIFTING CAPACITY

CX370D 2 PIECE BOOM

Front Side	REACH											
	0.0 m		2.0 m		4.0 m		6.0 m		8.0 m		At max reach	

LC UNDERCARRIAGE - Standard arm 3.25 m, 600 mm shoes, max reach 9.71 m

8.0 m								8200*	8200*			6720*	6720*	7.64
6.0 m								8570*	8570*	6750*	6750*	5790*	5790*	8.86
4.0 m					18620*	18620*		9910*	9910*	9780*	8510	5430*	5160	9.50
2.0 m			16890*	16890*	21150*	18990		12320*	10710*	7790*	6830	5410*	4860	9.70
0 m			20110	20110	21730*	18650		14060*	10280	15290*	11450	5710*	4940	9.48
-2.0 m	20410*	20410*	28440*	28440*	22160*	17750		14180*	9740	9300*	6260	6400*	5490	8.80
-4.0 m	19960*	19960*	36330*	36330*	20250*	17700		22830*	22830*			5580*	5580*	7.06

LC UNDERCARRIAGE - Short arm 2.63 m, 600 mm shoes, max reach 9.16 m

10.0 m					12540*	12540*						12010*	12010*	4.43
8.0 m										8860*	8860*	7850*	7850*	6.93
6.0 m					13350*	13350*	9150*	9150*	7270*	7000	6580*	6540		8.25
4.0 m					19280*	19280*	10640*	10540	7500*	6970	6110*	5590		8.94
2.0 m					21130*	18780	13210*	10820	8150*	6700	6070*	5250		9.15
0 m			20110*	20110*	21810*	18220	14080*	10090	8930*	6380	6430*	5380		8.91
-2.0 m	19200*	19200*	33470*	33470*	22130*	17640	14150*	9590	7620*	6260	6260*	6090		8.19
-4.0 m			35040*	35040*	17730*	17730*	8670*	8670*						

NLC UNDERCARRIAGE - Standard arm 3.25 m, 600 mm shoes, max reach 9.71 m

8.0 m								8200*	8200*			6720*	6720*	7.64
6.0 m								8570*	8570*	6750*	6720*	5790*	5460	8.86
4.0 m					18620*	18010		9910*	9890	9780*	7820	5430*	4720	9.50
2.0 m			16890*	16890*	21150*	17320		12320*	10220	7790*	6340	5410*	4440	9.70
0 m			20110*	20110*	21730*	16800		14060*	9400	15290*	10400	5710*	4510	9.48
-2.0 m	20410*	20410*	28440*	28440*	22160*	15930		14180*	8870	9300*	5710	6400*	5000	8.80
-4.0 m	19960*	19960*	36330*	36330*	20250*	15880		22830*	22830*			5580*	5580*	7.06

NLC UNDERCARRIAGE - Short arm 2.63 m, 600 mm shoes, max reach 9.16 m

10.0 m					12540*	12540*						12010*	12010*	4.43
8.0 m								8860*	8860*			7850*	7850*	6.93
6.0 m					13350*	13350*	9150*	9150*	7270*	6430	6580*	6000		8.25
4.0 m					19280*	17840	10640*	9860	7500*	6400	6110*	5110		8.94
2.0 m					21130*	17110	13210*	9930	8150*	6140	6070*	4800		9.15
0 m			20110*	20110*	21810*	16390	14080*	9210	8930*	5830	6430*	4910		8.91
-2.0 m	19200*	19200*	33470*	33470*	22130*	15830	14150*	8730	7620*	5710	6260*	5560		8.19
-4.0 m			35040*	35040*	17730*	15940	8670*	8670*						

* The above loads (kg) are compliant to the ISO standards and refer to the excavator equipped without bucket. The indicated loads are no more than 87% of hydraulic system lift capacity or 75% of static tipping load. Values marked with an asterisk (*) are limited by the hydraulic lifting capacity.

BUCKETS

CX370D MONO

CX370D LC

HEAVY DUTY BUCKET (DIRECT MOUNT)

CAPACITY m ³ (ISO7451 HEAPED)	WIDTH mm	WEIGHT kg	ARM 3.25 m	ARM 2.63 m	ARM 2.20 m
0.91	900	1213	○	○	○
1.19	1100	1338	○	○	○
1.33	1200	1439	○	○	○
1.54	1350	1533	○	○	○
1.75	1500	1666	●	●	○
2.03	1700	1829	■	●	●
2.17	1800	1894	■	■	●

HEAVY DUTY SCOOP BUCKET (WITH CASE MULTI-FIT S COUPLER)

CAPACITY m ³ (ISO7451 HEAPED)	WIDTH mm	WEIGHT kg	ARM 3.25 m	ARM 2.63 m	ARM 2.20 m
0.91	900	1188	○	○	○
1.19	1100	1316	○	○	○
1.33	1200	1418	○	○	○
1.54	1350	1514	●	●	○
1.75	1500	1648	■	●	●
2.03	1700	1801	×	■	■
2.17	1800	1867	×	■	■

ROCK BUCKET (DIRECT MOUNT)

CAPACITY m ³ (ISO7451 HEAPED)	WIDTH mm	WEIGHT kg	ARM 3.25 m	ARM 2.63 m	ARM 2.20 m
0.91	900	1254	○	○	○
1.19	1100	1382	○	○	○
1.33	1200	1480	○	○	○
1.54	1350	1576	○	○	○
1.75	1500	1706	●	●	○
2.03	1700	1872	■	●	●
2.17	1800	1939	■	■	●

ROCK SCOOP BUCKET (WITH CASE MULTI-FIT S COUPLER)

CAPACITY m ³ (ISO7451 HEAPED)	WIDTH mm	WEIGHT kg	ARM 3.25 m	ARM 2.63 m	ARM 2.20 m
0.91	900	1207	○	○	○
1.19	1100	1338	○	○	○
1.33	1200	1438	○	○	○
1.54	1350	1534	●	●	○
1.75	1500	1665	■	●	●
2.03	1700	1821	×	■	■
2.17	1800	1889	×	■	■

CX370D NLC

HEAVY DUTY BUCKET (DIRECT MOUNT)

CAPACITY m ³ (ISO7451 HEAPED)	WIDTH mm	WEIGHT kg	ARM 3.25 m	ARM 2.63 m	ARM 2.20 m
0.91	900	1213	○	○	○
1.19	1100	1338	○	○	○
1.33	1200	1439	○	○	○
1.54	1350	1533	●	○	○
1.75	1500	1666	■	●	●
2.03	1700	1829	■	■	●
2.17	1800	1894	×	■	■

HEAVY DUTY SCOOP BUCKET (WITH CASE MULTI-FIT S COUPLER)

CAPACITY m ³ (ISO7451 HEAPED)	WIDTH mm	WEIGHT kg	ARM 3.25 m	ARM 2.63 m	ARM 2.20 m
0.91	900	1188	○	○	○
1.19	1100	1316	○	○	○
1.33	1200	1418	●	○	○
1.54	1350	1514	■	●	●
1.75	1500	1648	■	■	●
2.03	1700	1801	×	×	■
2.17	1800	1867	×	×	■

ROCK BUCKET (DIRECT MOUNT)

CAPACITY m ³ (ISO7451 HEAPED)	WIDTH mm	WEIGHT kg	ARM 3.25 m	ARM 2.63 m	ARM 2.20 m
0.91	900	1254	○	○	○
1.19	1100	1382	○	○	○
1.33	1200	1480	○	○	○
1.54	1350	1576	●	○	○
1.75	1500	1706	■	●	●
2.03	1700	1872	■	■	●
2.17	1800	1939	×	■	■

ROCK SCOOP BUCKET (WITH CASE MULTI-FIT S COUPLER)

CAPACITY m ³ (ISO7451 HEAPED)	WIDTH mm	WEIGHT kg	ARM 3.25 m	ARM 2.63 m	ARM 2.20 m
0.91	900	1207	○	○	○
1.19	1100	1338	○	○	○
1.33	1200	1438	●	○	○
1.54	1350	1534	■	●	●
1.75	1500	1665	×	■	●
2.03	1700	1821	×	×	■
2.17	1800	1889	×	×	■

BUCKETS

CX370D 2 PIECE BOOM

CX370D LC

HEAVY DUTY BUCKET (DIRECT MOUNT)

CAPACITY m ³ (ISO7451 HEAPED)	WIDTH mm	WEIGHT kg	ARM 3.25 m	ARM 2.63 m
0.91	900	1220	○	○
1.19	1100	1340	○	○
1.33	1200	1440	○	○
1.54	1350	1540	○	○
1.75	1500	1670	●	●
2.03	1700	1830	■	■
2.17	1800	1900	■	■

ROCK BUCKET (DIRECT MOUNT)

CAPACITY m ³ (ISO7451 HEAPED)	WIDTH mm	WEIGHT kg	ARM 3.25 m	ARM 2.63 m
0.91	900	1260	○	○
1.19	1100	1390	○	○
1.33	1200	1480	○	○
1.54	1350	1580	○	○
1.75	1500	1710	●	●
2.03	1700	1880	■	■
2.17	1800	1940	■	■

HEAVY DUTY SCOOP BUCKET (WITH CASE MULTI-FIT S COUPLER)

CAPACITY m ³ (ISO7451 HEAPED)	WIDTH mm	WEIGHT kg	ARM 3.25 m	ARM 2.63 m
0.91	900	1190	○	○
1.19	1100	1320	○	○
1.33	1200	1420	○	○
1.54	1350	1520	●	●
1.75	1500	1650	■	■
2.03	1700	1800	×	■

ROCK SCOOP BUCKET (WITH CASE MULTI-FIT S COUPLER)

CAPACITY m ³ (ISO7451 HEAPED)	WIDTH mm	WEIGHT kg	ARM 3.25 m	ARM 2.63 m
0.91	900	1210	○	○
1.19	1100	1340	○	○
1.33	1200	1440	●	○
1.54	1350	1540	●	●
1.75	1500	1670	■	■
2.03	1700	1820	×	■

CX370D NLC

HEAVY DUTY BUCKET (DIRECT MOUNT)

CAPACITY m ³ (ISO7451 HEAPED)	WIDTH mm	WEIGHT kg	ARM 3.25 m	ARM 2.63 m
0.91	900	1220	○	○
1.19	1100	1340	○	○
1.33	1200	1440	○	○
1.54	1350	1540	●	●
1.75	1500	1670	■	●
2.03	1700	1830	■	■
2.17	1800	1900	×	■

ROCK BUCKET (DIRECT MOUNT)

CAPACITY m ³ (ISO7451 HEAPED)	WIDTH mm	WEIGHT kg	ARM 3.25 m	ARM 2.63 m
0.91	900	1260	○	○
1.19	1100	1390	○	○
1.33	1200	1480	○	○
1.54	1350	1580	●	●
1.75	1500	1710	■	●
2.03	1700	1880	×	■

HEAVY DUTY SCOOP BUCKET (WITH CASE MULTI-FIT S COUPLER)

CAPACITY m ³ (ISO7451 HEAPED)	WIDTH mm	WEIGHT kg	ARM 3.25 m	ARM 2.63 m
0.91	900	1190	○	○
1.19	1100	1320	●	○
1.33	1200	1420	●	●
1.54	1350	1520	■	■
1.75	1500	1650	×	■

ROCK SCOOP BUCKET (WITH CASE MULTI-FIT S COUPLER)

CAPACITY m ³ (ISO7451 HEAPED)	WIDTH mm	WEIGHT kg	ARM 3.25 m	ARM 2.63 m
0.91	900	1210	○	○
1.19	1100	1340	●	○
1.33	1200	1440	●	●
1.54	1350	1540	■	■
1.75	1500	1670	×	■

www.casece.com

EXPERTS FOR THE REAL WORLD
SINCE 1842

CASE
CONSTRUCTION



Form No. 20193GB - MediaCross Firenze - 12/18

**CNH INDUSTRIAL
DEUTSCHLAND GMBH**
Case Baumaschinen
Benzstr. 1-3 - D-74076 Heilbronn
DEUTSCHLAND

CNH INDUSTRIAL FRANCE, S.A.
16-18 Rue des Rochettes
91150 Morigny-Champigny
FRANCE

CNH INDUSTRIAL - UK
First Floor, Barclay Court 2,
Heavens Walk,
Doncaster - DN4 5HZ
UNITED KINGDOM

CNH INDUSTRIAL - SOUTH AFRICA
Waterfall Business Park
Bekker Street, Howick Close
1685 Midrand - Johannesburg
REPUBLIC OF SOUTH AFRICA

**CNH INDUSTRIAL
MAQUINARIA SPAIN, S.A.**
Avenida Aragón 402
28022 Madrid
ESPAÑA

CNH INDUSTRIAL ITALIA SPA
Strada di Settimo, 323
10099 San Mauro Torinese (TO)
ITALIA

**CASE CUSTOMER CENTRE
PARIS**
RN 330 - Penchard
77122 - Monthyon
FRANCE

CNH INDUSTRIAL - MIDDLE EAST
DAFZA - Dubai Airport Free Zone
West Wing 4 B, Office 642
P.O. Box 54588, Dubai,
UNITED ARAB EMIRATES

NOTE: Standard and optional fittings can vary according to the demands and specific regulations of each country. The illustrations may include optional rather than standard fittings - consult your Case dealer. Furthermore, CNH Industrial reserves the right to modify machine specifications without incurring any obligation relating to such changes.

Conforms to directive 2006/42/EC

CASE
00800-2273-7373

The call is free from a land line.
Check in advance with your Mobile Operator if you will be charged. Toll free number not available from all calling areas.

